

MWPS-74403

40' x 48' Bulk Fertilizer Storage, Stud Frame

Four 12'x36' bins for bulk fertilizer storage and handling. Sliding access doors. Roof loading hatch.

WARRANTY DISCLAIMER

This plan provides conceptual information only. **Neither MidWest Plan Service nor any of the cooperating land grant universities, or their respective agents or employees, have made, and do not hereby make, any representation, warranty or covenant with respect to the specifications in this plan.** Additional professional services will be required to tailor this plan to your situation, including but not limited to: assurance of compliance with codes and regulations; review of specifications for materials and equipment; supervision of site selection, bid letting and construction; and provision for utilities, waste management, roads or other access.

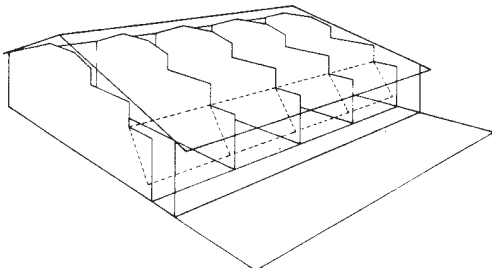

MIDWEST PLAN SERVICE
Cooperative Extension Work in Agriculture and Home Economics and Agricultural Experiment Stations of North Central Region - USDA Cooperating
40'x48' Bulk Fertilizer Storage, Stud Frame
Title Page
MIDWEST PLAN NO. 74403

CAUTION!

Additional professional services will be required to tailor this plan to your situation, including but not limited to: assurance of compliance with codes and regulations; review of specifications for materials and equipment; supervision of site selection, bid letting and construction; and provision for utilities, waste management, roads or other access. **Furthermore, any deviation from the given specifications may result in structural failure, property damage, and personal injury including loss of life.**

**MWPS Plan 74403
Bulk Fertilizer Storage Bldg.**

Bulk fertilizers exert a much higher pressure than commonly stored grains. Fertilizers vary in weight up to 70 or 80 pcf. This building is designed for storage of an 80 pcf material. Use air-entrained concrete at 3000 psi in 28 days.

Welded rods are shown with this plan for wall support. Turn-buckles, threaded tie rods and chains have been used successfully. Connections of these types of ties can be weaker than the tie itself. Consult a professional engineer for design.

Do not handle any fertilizer with added fungicide or herbicide with the equipment used to handle commercial grain. Use zinc-coated nails to reduce the effects of corrosion.

Fertilizers can absorb moisture from the air or from contact with free water causing caking. Caking can also be caused by the pressure of the fertilizer itself and by the presence of fine materials in the fertilizer. Urea and ammonium nitrate tend to cake most. Do not store urea and ammonium nitrate together as their tendency to absorb water greatly increases when combined.

Double walls and light colored exterior surfaces can reduce caking. Seal all joints at the roof, wall and floor with a caulking compound or rubber filler strips. Cover auger openings with a polyethylene vapor barrier when not in use.

Coat all exposed metal with an epoxy-tar paint.

Minimize augering as it tends to break down fertilizer. Power requirements are increased 2 to 3 times over that required for grains. Power requirements increase with angle of elevation. Select augers with bearings outside the tube to reduce corrosion effects. Belt conveyors cause less breakdown of material and require less power but may be more expensive.

Dust-tight, 150-watt light fixtures inside each bin and over work alley. Sealed "Press-Switch"-type wall switches for all 110-volt service. PVC plastic conduit and pipe fittings.

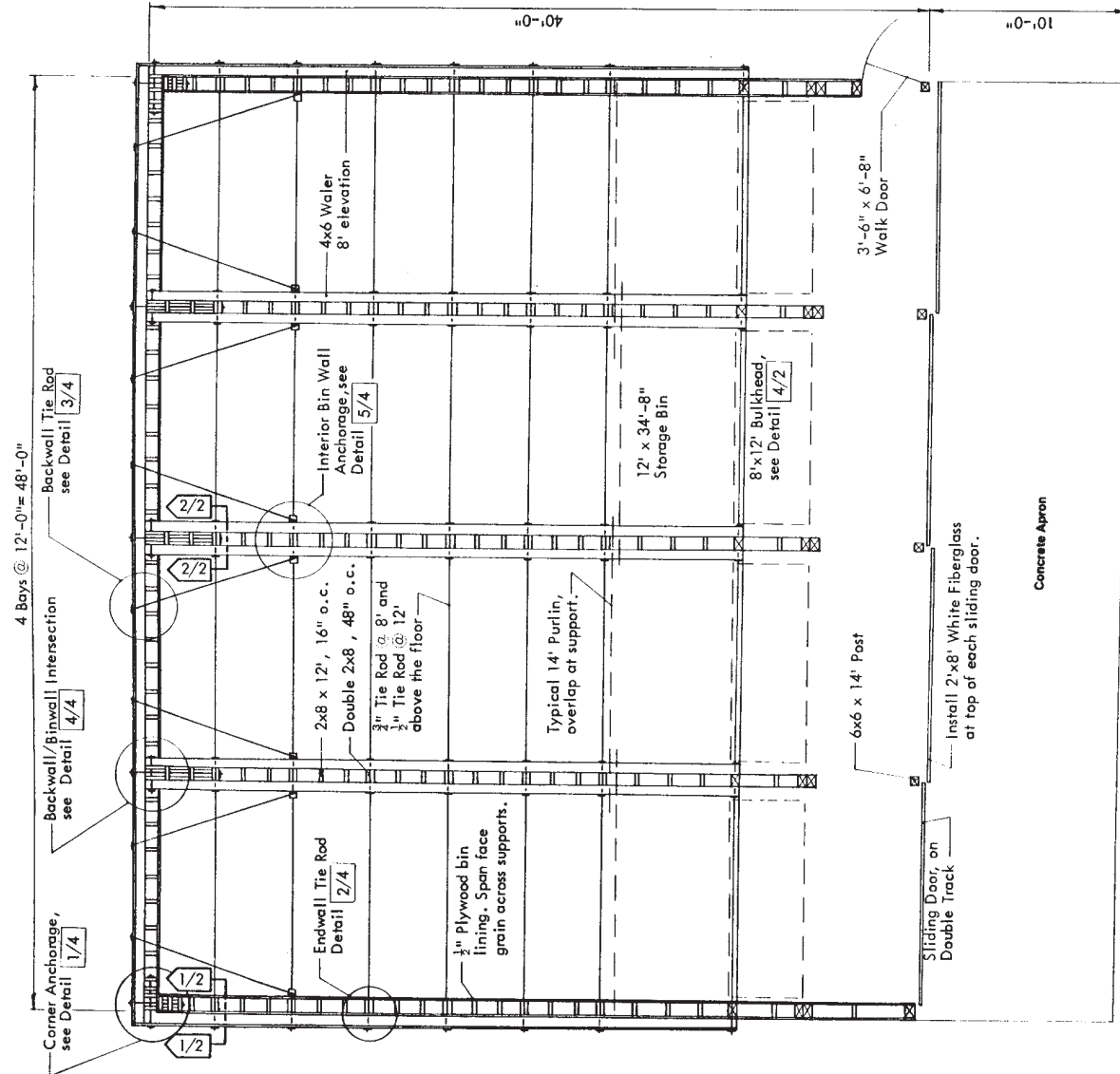

FLOOR PLAN—1/1

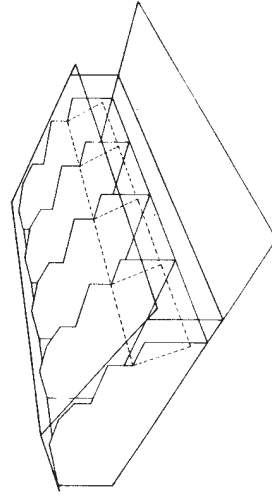

Section & Detail Indicator

Section _____ Page No. Where Detail is Found _____

Detail _____ Direction You Are Looking _____ Section or Detail No. _____

MWPS MIDWEST PLAN SERVICE

Cooperative Extension & Research in Agriculture & Home Economics in the 12 North Central Universities—USDA Cooperating

Bulk Fertilizer Storage Bldg.
Stud Frame 500-600 Ton Capacity

4 Pages Plan No. mwps-74403 Page 1 of 4

You may require professional services to complete this general plan, to fit it to your situation, and to include consideration of: site selection and preparation; provisions for utilities, waste management, and roads or other access; assurance of compliance with codes and regulations; specifications for some materials and equipment; and supervision of bidding and construction.

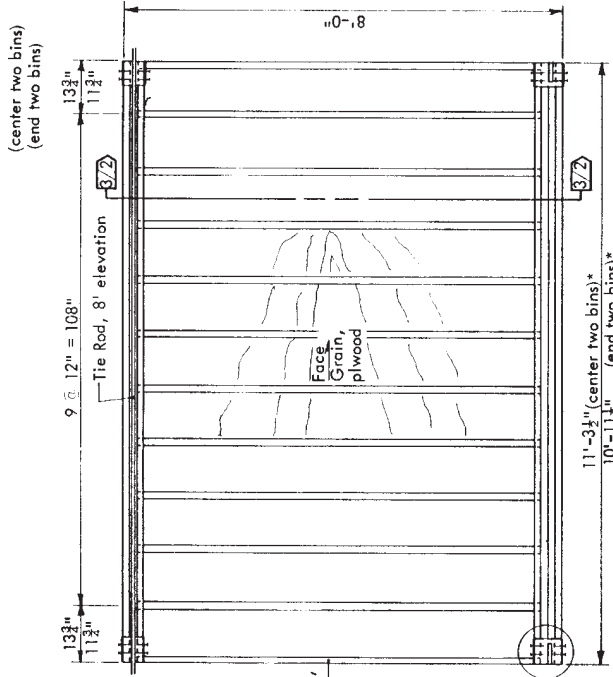

*A allows approximate 3/8" clearance between bin lining. See also 7/4

BULKHEAD DETAIL—4/2

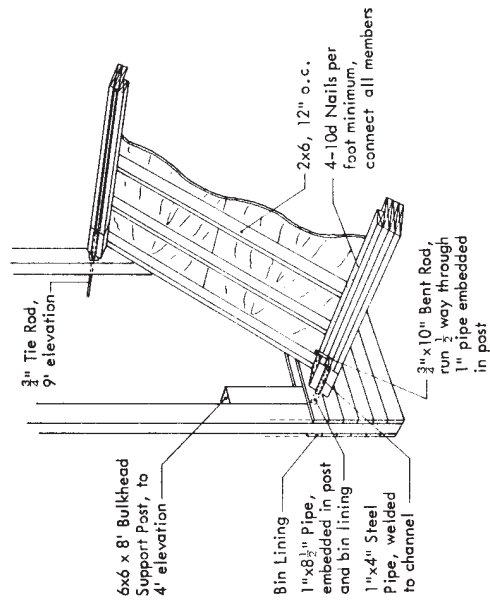

BIN BULKHEAD DETAIL—6/2

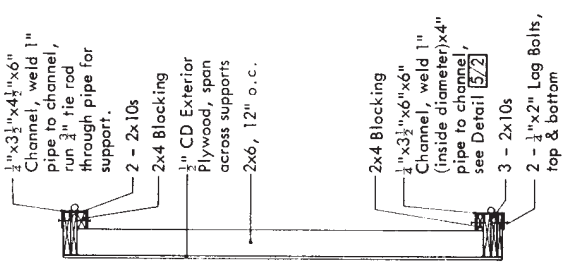

BULKHEAD CROSS SECTION—3/2

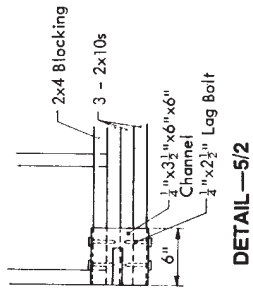

DETAIL—5/2

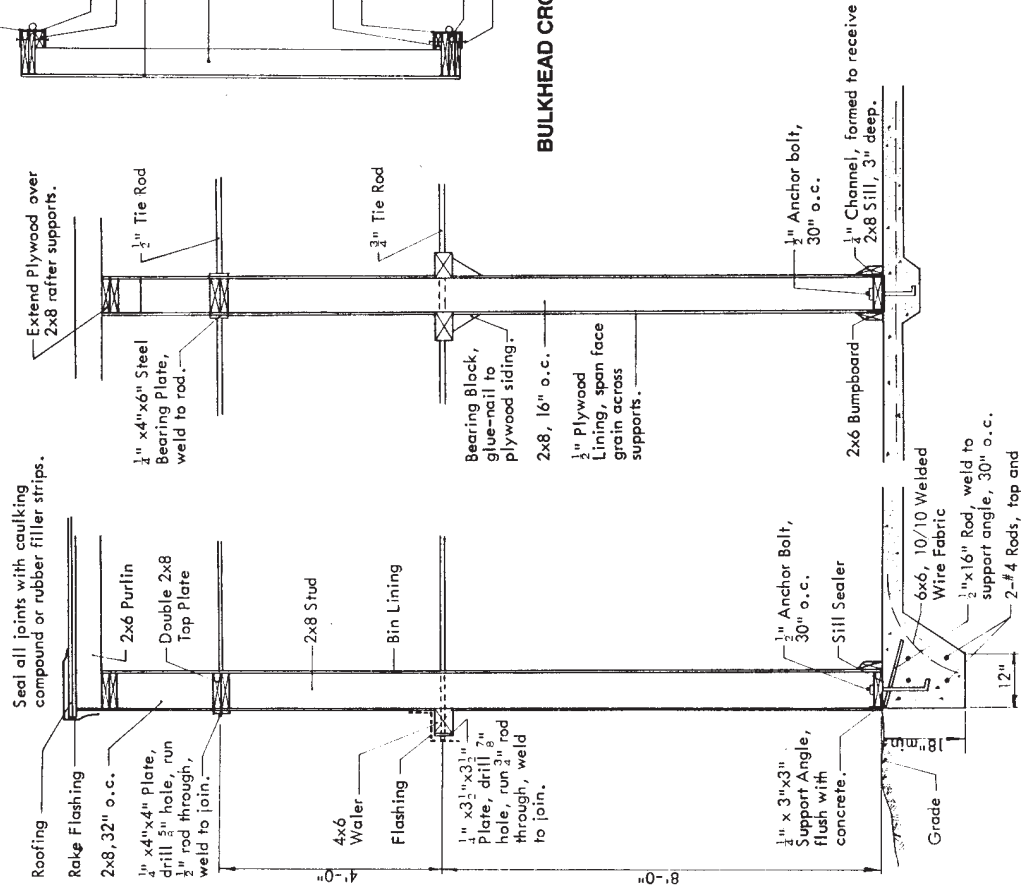

INTERIOR WALL SECTION—2/2

ENDWALL DETAIL—1/2

MIDWEST PLAN SERVICE			
Bulk Fertilizer Storage Bldg.			
Stud Frame 500-600 Ton Capacity			
Rev.	Plan No.	Page	
	74403	2	4
mups-74403			

Copyright © 1979 Midwest Plan Service, Ames, IA 50011

Anchor purlin with 2-50d ringshank nails, plumbers strap or framing clip.

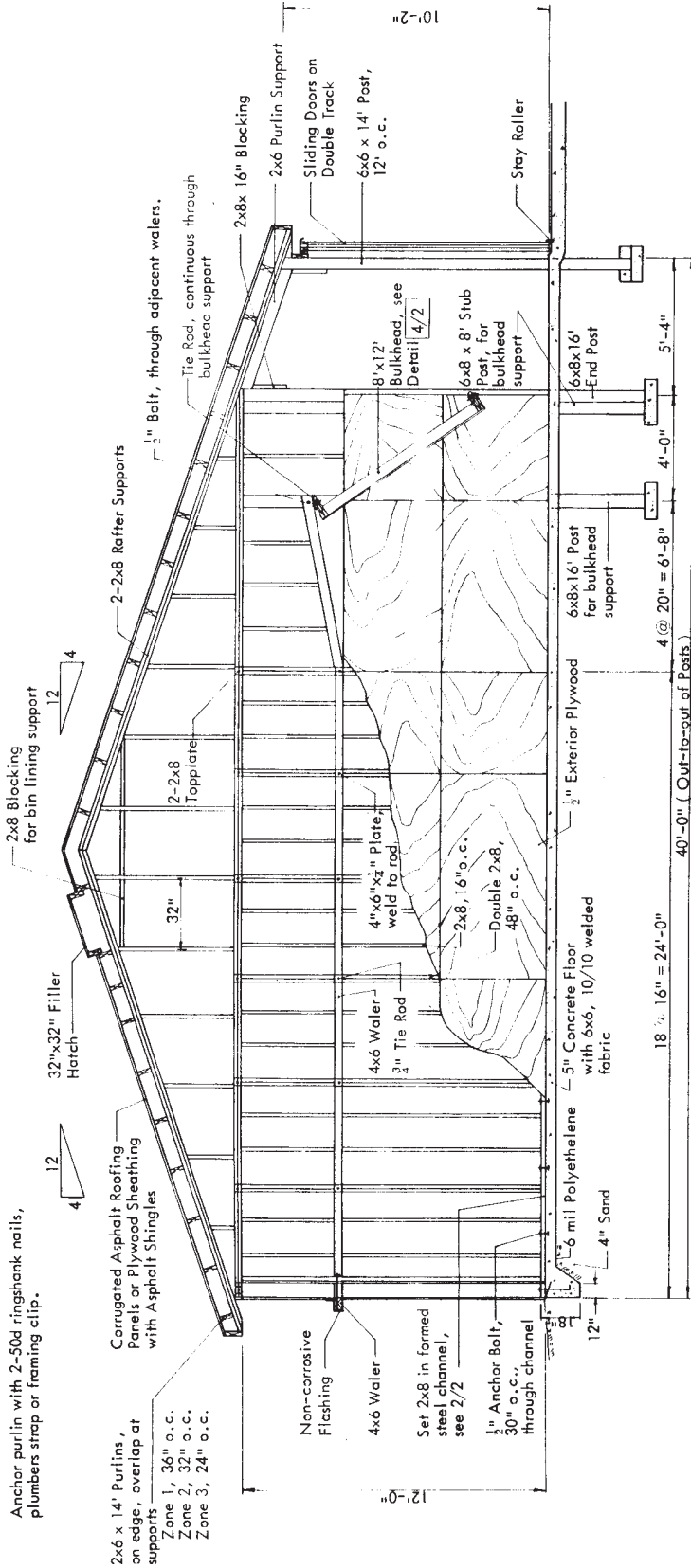

CROSS SECTION—1/3

LIST OF MATERIALS

Quantity	Description	Notes
188	2x8x12 Sills, Sills, and Plates	
5	6x6x14 Pressure Treated Posts	
10	6x8x16 Pressure Treated Posts	
75	2x8x16 Sills, Plates and Rafter Supports	
3	2x4x16 Blocking	
64	Zone 1	
72	Zone 2	
88	Zone 3	
2100 ft ²	Roofing Material	
1800 ft ²	Sliding Material	
164	Bin Lining	
22	4x6x16 P.T. Walkers	
48	Bulkheads (4)	
20	2x10x12	
12	4x8x1/2 Plywood	
8	1/2 x 3 1/2 x 6 Channels	
8	1/4 x 3 1/2 x 4 1/2 x 6 Channels	
4	5" Gutter	
4	2x8 White Fiberglass in sliding doors	
1	3x6x8 Walk Doors	
1	Art-Entrained Concrete	
42	Sand and gravel/fill as required	
	Nails	

Siding Options:
 Exterior Plywood, stained or MDO Plywood, painted.
 Caulk or Batten all joints, or non-corrosive siding such as corrugated asphalt, see roofing specifications for application details.

Use 8d galvanized nails, 6" o.c. at plywood edges, 12" o.c. at supports, bin lining and roof sheathing.

Use 6d galvanized for ext. plywood siding.

PREFERRED LUMBER SPECIFICATIONS
ROOF PURLINS
 No. 2 (Doug Fir or Southern Pine)
HEADERS, TOP PLATES, STUDS
 No. 2 (Doug Fir or Southern Pine)
PLYWOOD
 Bin Lining
 32/16 or 1/2 AC, Ext. Group 1
 Span Face Grain across supports.
Roof Sheathing
 C-C Exterior, Unsheathed
 Zone 1 and 2, 32/16 (1/2" or 5/8")
 Zone 3, 24/10 (1/2" or 5/8")
 *Span Face grain across supports.
 *Identical face grain—indicates strength
SILLS AND FASCIA
 Pressure Impervious Treated (Southern Pine)
 Preservative
 CCA (Type A or B)—0.40 pcf, ACA or CCA (Type A or B)—0.23 pcf retention.
 P.T. means lumber pressure preservative treated against insect and fungus attack.

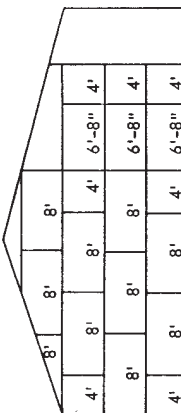

Plywood Cutting Diagram

nmws MIDWEST PLAN SERVICE
Bulk Fertilizer Storage Bldg.
 Stud Frame 500-600 Ton Capacity
 Rev. _____ Plan No. 74403 Page 3 of 4
 mwpj- _____

Copyright © 1979 Midwest Plan Service, Ames, IA 50011

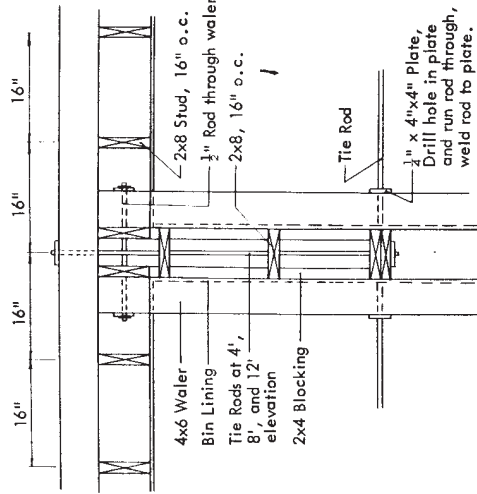
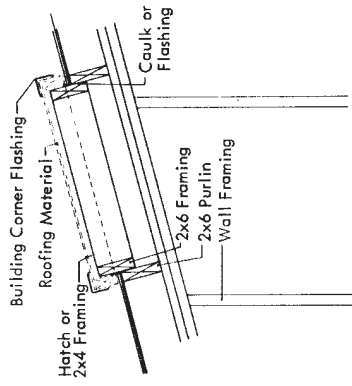

BACKWALL/BINWALL INTERSECTION—4/4

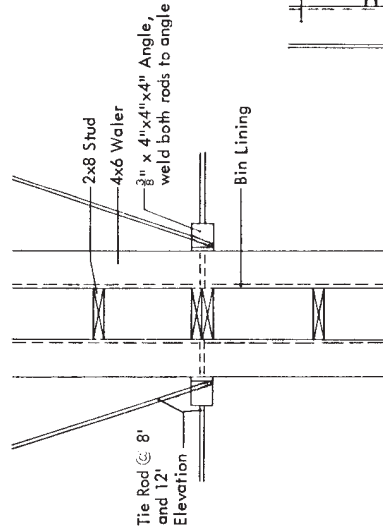

INTERIOR BINWALL DETAIL—5/4

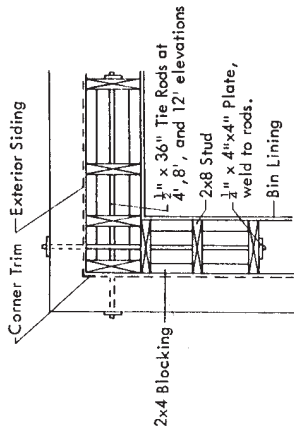

CORNER DETAIL—1/4

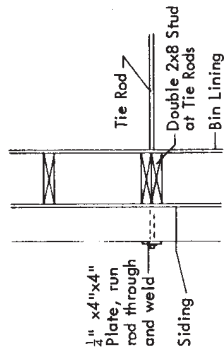

ENDWALL TIE ROD DETAIL—2/4

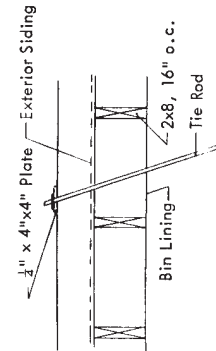

BACKWALL TIE ROD DETAIL—3/4

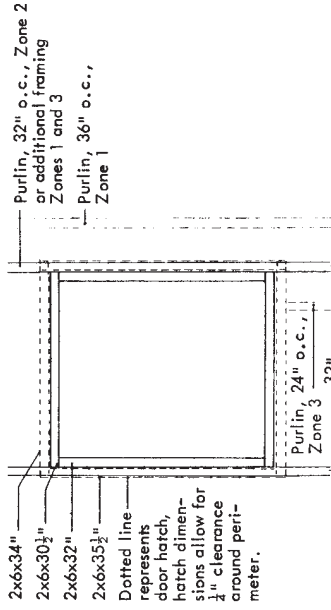

ROOF HATCH DETAIL—6/4

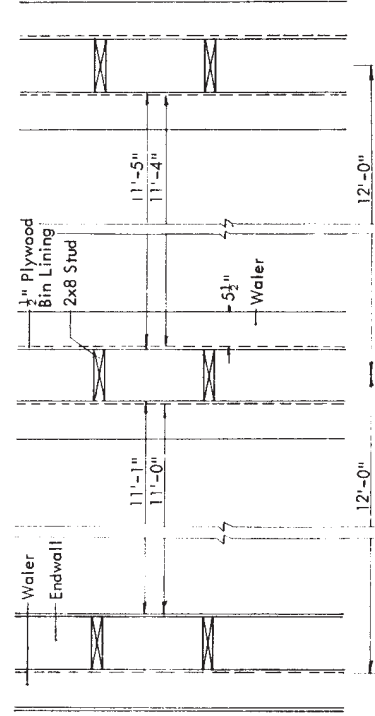

BIN CLEARANCE DETAIL—7/4

TRUSSES

July, 1984

Dear Customer:

When this plan was released, the last sheet had details for glue-nailed truss selection. Most buildings are erected with purchased trusses. The truss sheet did not have space enough to present all that was needed to build glue-nailed trusses.

Therefore, the sheet has been dropped. The plan has not yet been revised to include the following notes:

TRUSS NOTES

If you buy trusses:

Specify the span, slope, and spacing shown on the plan. Specify the roof and ceiling types. Require strength adequate for the wind and snow loads for your locality.

Require installation details specifying anchorage, bracing, and roofing and ceiling framing and attachment. If you buy glue-nailed trusses:

Have them built and installed to the recommendations in MWPS-9, *Designs for Glued Trusses*, Fourth Edition.

If you build your own trusses:

Get a copy of MWPS-9 and follow its recommendations.

Send \$5.00 for *Designs for Glued Trusses, MWPS-9* to:

Midwest Plan Service, 122 Davidson Hall, Iowa State University, Ames, IA 50011

Windbracing

Brace and anchor the trusses as they are placed. Bottom chord stiffeners are required at panel points unless a rigid ceiling is to be installed. Use king post crossbracing in all buildings.

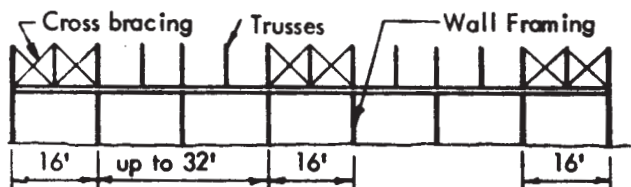
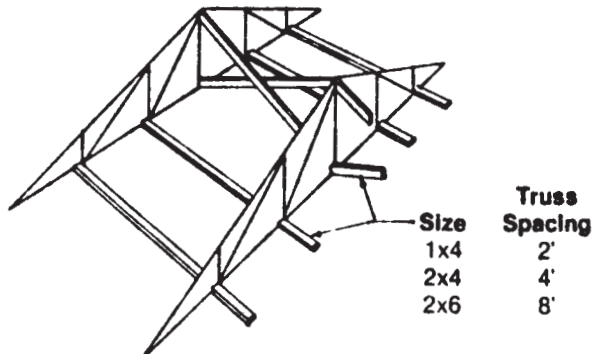

Wind Anchorage

Minimum fasteners for wind anchorage, both ends of each truss.

Truss span	Truss spacing		
	2'	4'	8'
20'-24'	1A or 1B	1A or 1B	2A or 1B
26'-30'	1A or 1B	1A or 1B	2A or 2B
32'-46'	1A or 1B	2A or 1B	3A or 2B
48'-50'	1A or 1B	2A or 1B	4A or 2B
52'-60'	1A or 1B	2A or 2B	4A or 3B

A - metal framing anchor

4-30d ring-shank nails = 1/2" bolt

B - 1/2" bolt

Roof Purlins

Stagger purlin joints for continuity across the trusses. Purlins may be laid flat with 2' and 4' truss spacings and butt joints used.

Alternating purlin lengths may be used in pole buildings where the poles are spaced evenly and the trusses are not. For poles 8' o.c. they may be of alternating 16' and 18' lengths with staggered and lapped end joints if pairs of trusses are mounted on alternate sides of the poles.

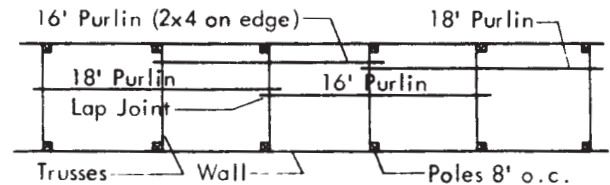

Overhang

For a 2' to 4' overhang, use the top chord and heel gusset design for a 1/3 larger snow load.

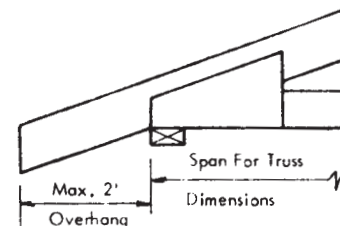

Loads

Install trusses to withstand the loads.

- Required by any applicable building code.
- Recommended by an engineer familiar with farm buildings in your area.
- Or, if necessary, estimated from the material below.

Ceiling Dead Load

- 0 psf allows for no materials in addition to the truss, bracing, and stiffeners.
- 5 psf ceiling dead load allows for a metal or plywood ceiling with insulation (warm livestock buildings).
- 8 psf ceiling dead load allows for a gypsum board ceiling with insulation (residential or light commercial buildings).

Roof Dead Load

Add the weights of the truss, purlins or decking, roofing, and roof insulation to get the dead load on the top chord.

Approximate weights of trusses, psf

Example: a 4-web truss for 4' spacing with 2x8 top chord and 2x6 bottom chord weighs about $1.3 + 0.7 = 2.0$ psf. Dashed lines in table indicate example.

Chord size Top	Bottom	Truss spacing		
		2'	4'	8'
2x4	2x4	1.6	0.8	0.4
2x6	2x4	2.0	1.0	0.5
2x6	2x6	2.4	1.2	0.6
2x8	2x6	2.7	1.3	0.7
2x10	2x4 + 2x4	3.3	1.6	0.8
2x12	2x4 + 2x6	4.0	2.0	1.0
2x12	2x6 + 2x6	4.4	2.2	1.1

Add the following for:

2-&4-Web Truss	1.4	0.7	0.4
6 Web Truss	2.1	1.2	0.6

Recommended snow loads

For roofs up to about $\frac{1}{2}$ slope for buildings outside the jurisdiction of a building code. Farm buildings:

50-yr map load x 0.9 for 25-yr x 0.8 for snow on roof.
Other buildings: 50-yr map load x 0.8 to convert from snow on ground to snow on roof.

Minimum recommended load is 12 psf. In areas where all of the maximum snow load results from a single storm without significant wind, the maximum roof load may equal the ground snow load.

Map load	Roof snow load	
	Farm	Other
15	12.0	12
20	14.4	16
30	21.6	24
40	28.8	32
50	36.0	40
60	43.2	48
70	50.4	56
80	57.6	64
90	64.8	72
100	72.0	80
110	79.2	88
120	86.4	96

Weights of roofing and ceiling materials

2x4s, 2' o.c.	0.7 psf
2x6s, 2' o.c.	1.1
1" lumber, solid	2.2 psf
1x3s, 16" o.c.	0.4
$\frac{3}{8}$ " plywood	1.1
$\frac{1}{2}$ " plywood	1.4
0.024" aluminum	0.4
28 ga steel	0.9
Asphalt shingles	2.6
Insulation, per inch of thickness	0.1-0.4

Wind Loads

For most areas of the U.S., trusses are designed to withstand winds of 80 mph on a building less than 30' high.

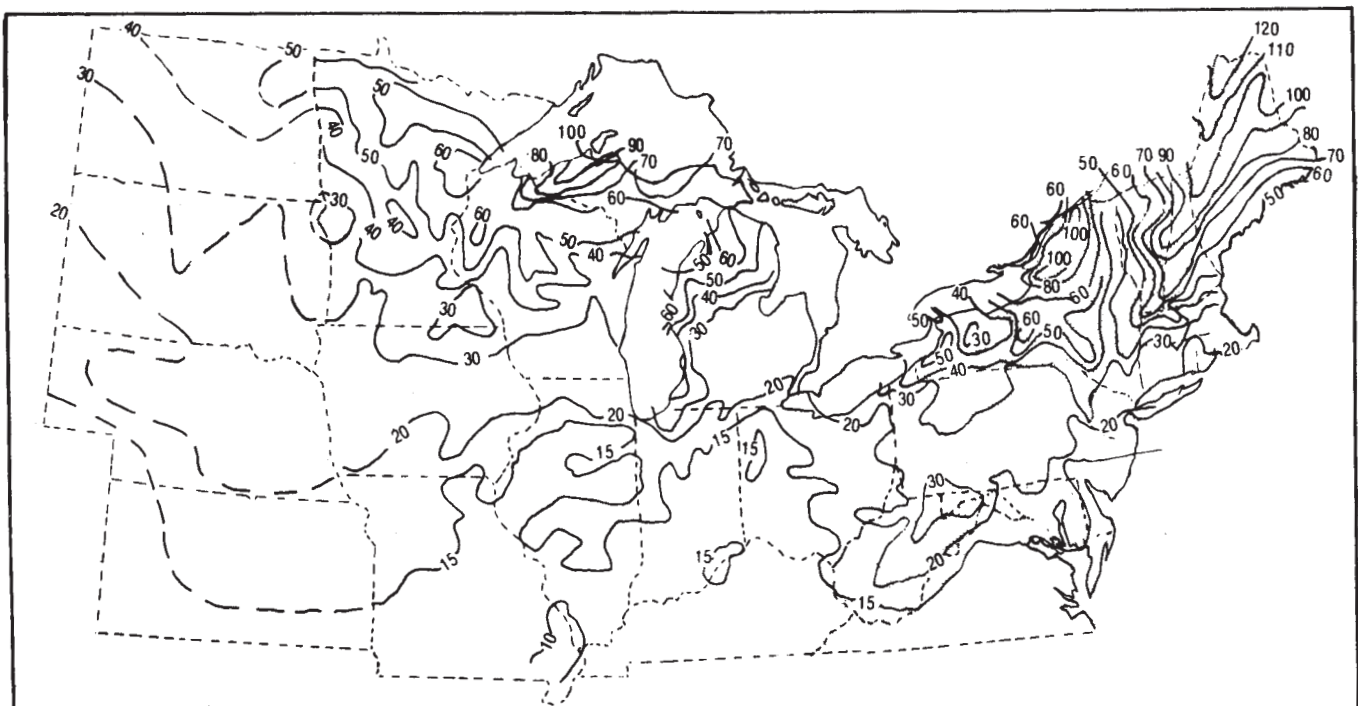

Snow load on the ground, 50-yr recurrence interval